

VENTILADORES CENTRÍFUGOS BAJA PRESIÓN

CENTRIFUGAL LOW PRESSURE FANS

VENTILATEURS CENTRIFUGES BASSE PRESSION

NIEDERDRUCK-RADIALVENTILATOREN

BVCR

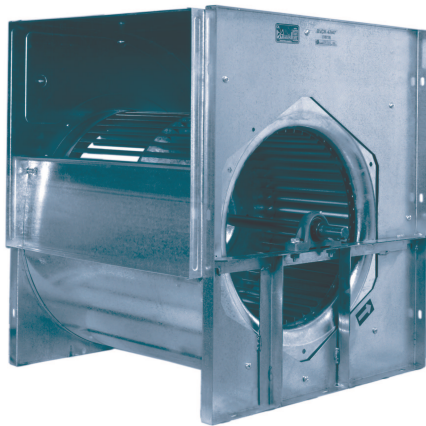

ES

CARACTERÍSTICAS GENERALES:

Serie compuesta por 6 tamaños distintos desde el 39/39 (15/15) hasta el 76/71 (30/28). Caudales desde 16.000 m³/h hasta 62.000 m³/h. Temperatura máxima de trabajo 85°C en continuo.

CARACTERÍSTICAS CONSTRUCTIVAS:

- Ventiladores totalmente fabricados en chapa galvanizada.
- Turbina multipala de alabes curvados hacia delante de doble oído.
- Eje transmisión con tratamiento anticorrosión.
- EL VENTILADOR SE SUMINISTRARÁ A EJE LIBRE.
- Eje de la transmisión que sobresale por los dos lados para permitir el montaje de poleas y correas.
- Montaje tipo cubic con paneles laterales que refuerzan todo el conjunto del ventilador.
- Ventilador con rodamientos a bolas de engrase permanente montados en aro de goma para evitar vibraciones.

APLICACIONES:

- Equipos de climatización y de tratamiento de aire.
- Instalación dentro de cajas de ventilación.
- Aerotermos centrífugos.

BAJO DEMANDA:

Montaje de ventilador completo con motor, poleas y correas.

EN

GENERAL FEATURES:

Range with 6 different sizes from 39/39 (15/15) until 76/71 (30/28). Air-flow from 16.000 m³/h until 62.000 m³/h. Maximum working temperature 85°C in continuous.

MANUFACTURING FEATURES:

- Fully made of galvanised steel sheet.
- All models fitted with double inlet forward curved impellers.
- Transmission shaft with anticorrosion treatment.
- The fan will be supplied with free shaft.
- The transmission shaft standing out in both fan sides to allow the assembly of the motor, pulleys and belts.
- Reinforced cubick assembly with the lateral pannels and a bearings base plate as well.
- Ball bearings greased for life assembled in a base support.

APPLICATIONS:

- Chillers and air cooling or air treatment equipments.
- Assembly inside cabinets.
- Centrifugal heaters.

UNDER REQUEST:

Full equipped fan with motor, pulleys and belts.

ACCESORIOS

ANCILLARIES

ACCESSOIRES

ZUBEHÖR

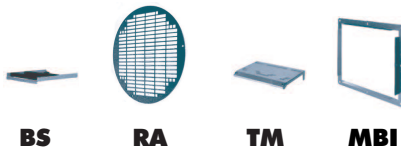

BS

RA

TM

MBI

FR

CARACTÉRISTIQUES GÉNÉRALES:

Série composte par 6 tailles de la 39/39 (15/15) à la 76/71 (30/28). Débits de 16.000 m³/h à 62.000 m³/h. Température maximale de l'air 85°C en continu.

CARACTÉRISTIQUES DE FABRICATION:

- Totalemnt construits en tôle d'acier galvanisée.
- Turbine de pales à action de double aspiration.
- Axe de la turbine avec traitement anticorrosion.
- VENTILATEUR LIVRÉ SANS MOTEUR.
- Axe qui sort des deux cotés pour permettre le montage de poulies et courroies de la transmission.
- Montage type cubique avec panneaux latérales qui renforcent l'ensemble du ventilateur.
- Roulements à graisse permanente montés sur antivibratoires.

APPLICATIONS:

- Unités de climatisation et traitement d'air.
- Caissons de ventilation.
- Aérothermes centrifuges.

OPTIONS DISPONIBLES:

Montage complète avec transmission et moteur.

DE

ALLGEMEINE MERKMALE:

Baureihe bestehend aus 6 verschiedenen Größen, von 39/39 (15/15) bis 76/71 (30/28). Luftfördermengen von 16.000 m³/h bis 62.000 m³/h. Maximale Arbeitstemperatur von 85 °C im Dauerbetrieb.

BAULICHE MERKMALE:

- Ventilatoren komplett aus verzinktem Blech hergestellt.
- Mehrschaufel-Turbine mit nach vorn geneigten Schaufelrädern mit doppelter Ansaugung.
- Kraftübertragungswelle mit Rostschutzbehandlung.
- DER VENTILATOR WIRD MIT FREIER WELLE GELIEFERT.
- Die Kraftübertragungswelle steht an beiden Seiten über, um die Montage von Riemenscheibe und Riemen zu ermöglichen.
- Montage des Bautyps Cubic, bei dem abgesehen von den Seitentafeln zur Verstärkung der Ventilatoreinheit auch eine Lageraufnahme eingeschlossen ist.

ANWENDUNGEN:

- Klimaanlage und Systeme zur Luftbehandlung.
- Einbau in Lüftungskästen.
- Radial-Luftheizungen.

AUF ANFRAGE:

Montage des kompletten Ventilators mit Motor, Riemenscheibe und Riemen.

VENTILADORES CENTRÍFUGOS BAJA PRESIÓN CENTRIFUGAL LOW PRESSURE FANS VENTILATEURS CENTRIFUGES BASSE PRESSION NIEDERDRUCK-RADIALVENTILATOREN

BVCR

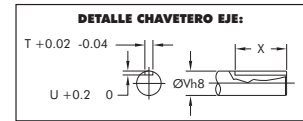
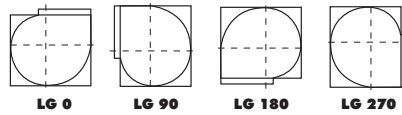
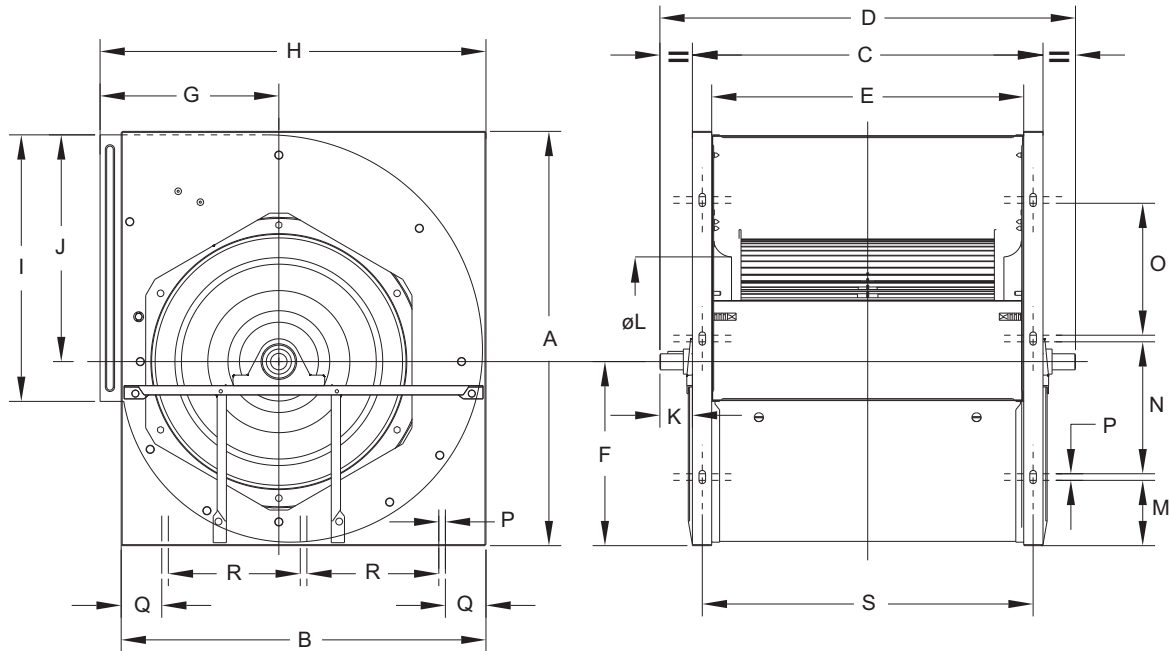

DIMENSIONES / DIMENSIONS / ENCOMBREMENT / ABMESSUNGEN (mm)

Model	A	B	C	D	E	F	G	H	I	J	K	L	M	N
BVCR 39/39 (15/15)	628	553	533	630	473	285	271	585	404	343	49	321	99	200
BVCR 47/47 (18/18)	748	653	616	728	556	335	311	685	483	413	56	397	109	250
BVCR 51/51 (20/20)	965	790	983	923	605	440	325	840	605	525	120	-	-	-
BVCR 56/56 (22/22)	1.045	860	736	976	655	473	350	910	695	572	120	-	-	-
BVCR 63/63 (25/25)	1.162	945	945	1.085	765	522	377	995	795	640	120	-	-	-
BVCR 76/71 (30/28)	1.395	1.155	968	1.208	890	618	467	1.205	935	777	120	-	-	-

Model	O	P	Q	R	S	T	U	V	X
BVCR 39/39 (15/15)	200	10	60	200	503	8	4	25	52
BVCR 47/47 (18/18)	250	10	60	250	686	8	4	25	52
BVCR 51/51 (20/20)	-	25	-	-	641	-	-	35	-
BVCR 56/56 (22/22)	-	25	-	-	694	-	-	35	-
BVCR 63/63 (25/25)	-	25	-	-	803	-	-	35	-
BVCR 76/71 (30/28)	-	25	-	-	926	-	-	40	-

Model	Pulg.	R.P.M max.	CV	m ³ /h	Kg
BVCR 39/39 (15/15)	15/15	1.100	5,5	16.000	34
BVCR 47/47 (18/18)	18/18	900	7,5	25.000	46
BVCR 51/51 (20/20)	20/20	800	10	29.000	84
BVCR 56/56 (22/22)	22/22	700	10	32.000	94
BVCR 63/63 (25/25)	25/25	550	15	42.000	113
BVCR 76/71 (30/28)	30/28	450	20	62.000	145

VENTILADORES CENTRÍFUGOS BAJA PRESIÓN
CENTRIFUGAL LOW PRESSURE FANS
VENTILATEURS CENTRIFUGES BASSE PRESSION
NIEDERDRUCK-RADIALVENTILATOREN

BV

19/19 (7/7)

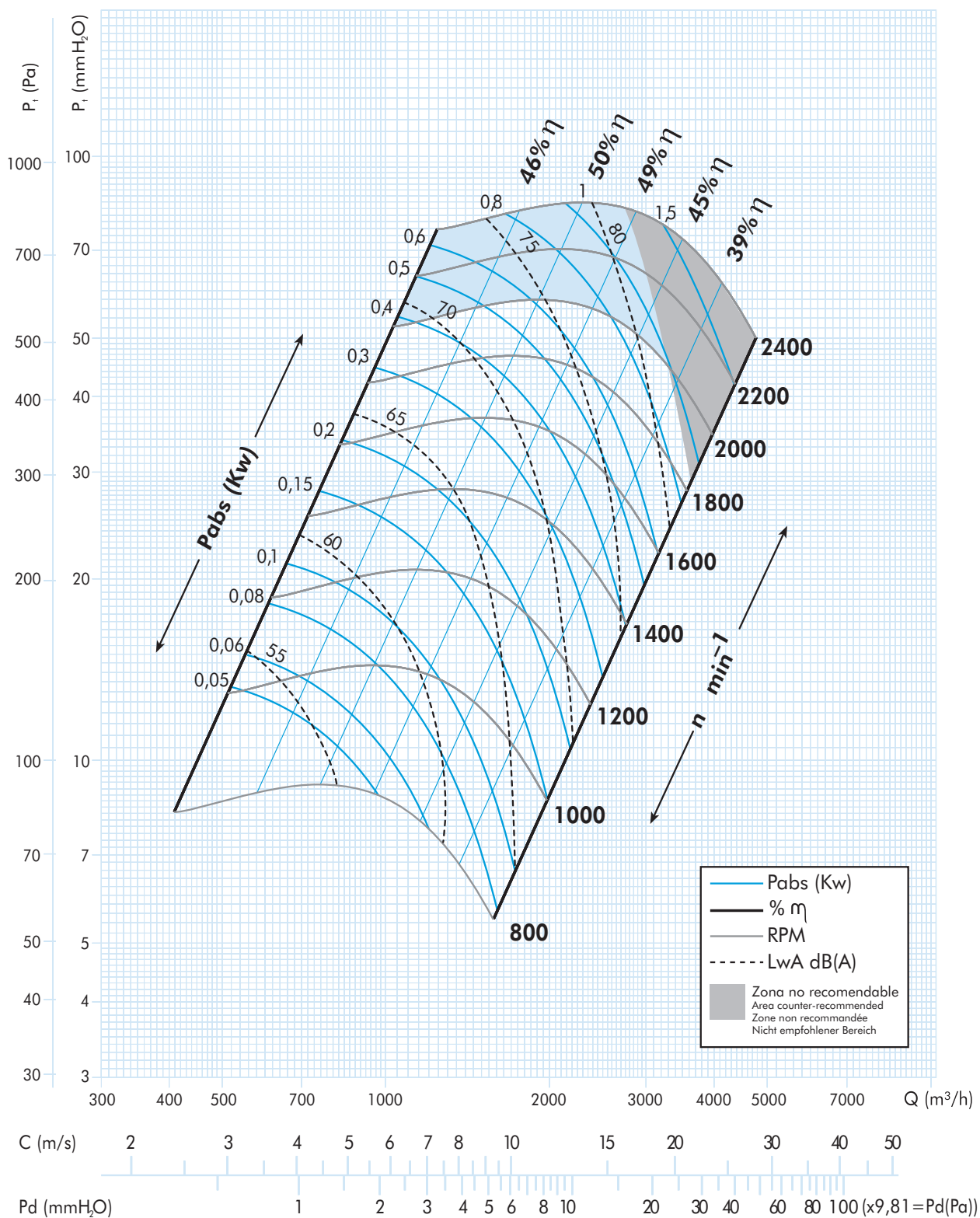

VENTILADORES CENTRÍFUGOS BAJA PRESIÓN
CENTRIFUGAL LOW PRESSURE FANS
VENTILATEURS CENTRIFUGES BASSE PRESSION
NIEDERDRUCK-RADIALVENTILATOREN

BV

25/20 (9/7)

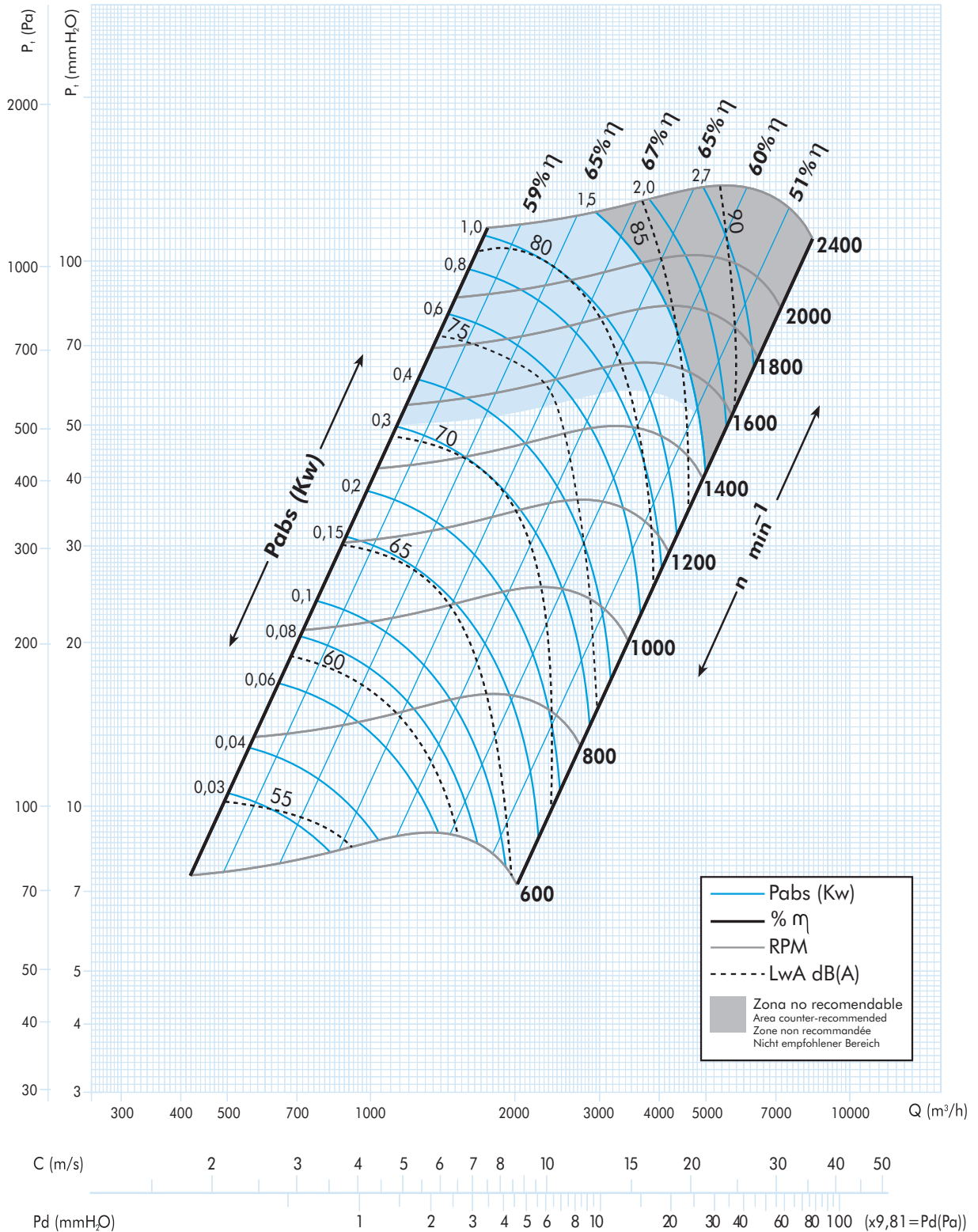

BV, BVC

25/25 (9/9)

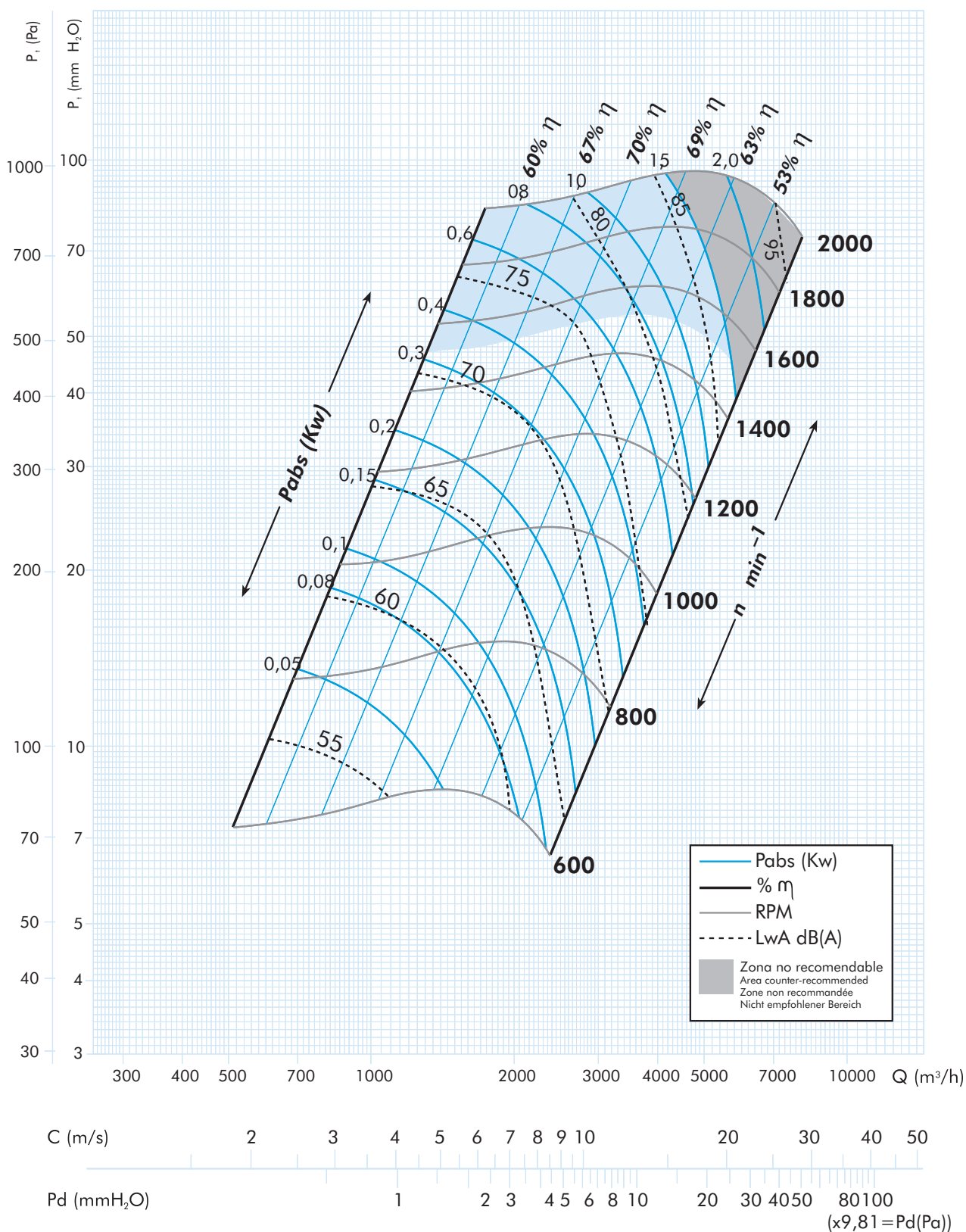

VENTILADORES CENTRÍFUGOS BAJA PRESIÓN
CENTRIFUGAL LOW PRESSURE FANS
VENTILATEURS CENTRIFUGES BASSE PRESSION
NIEDERDRUCK-RADIALVENTILATOREN

BV

28/21 (10/8)

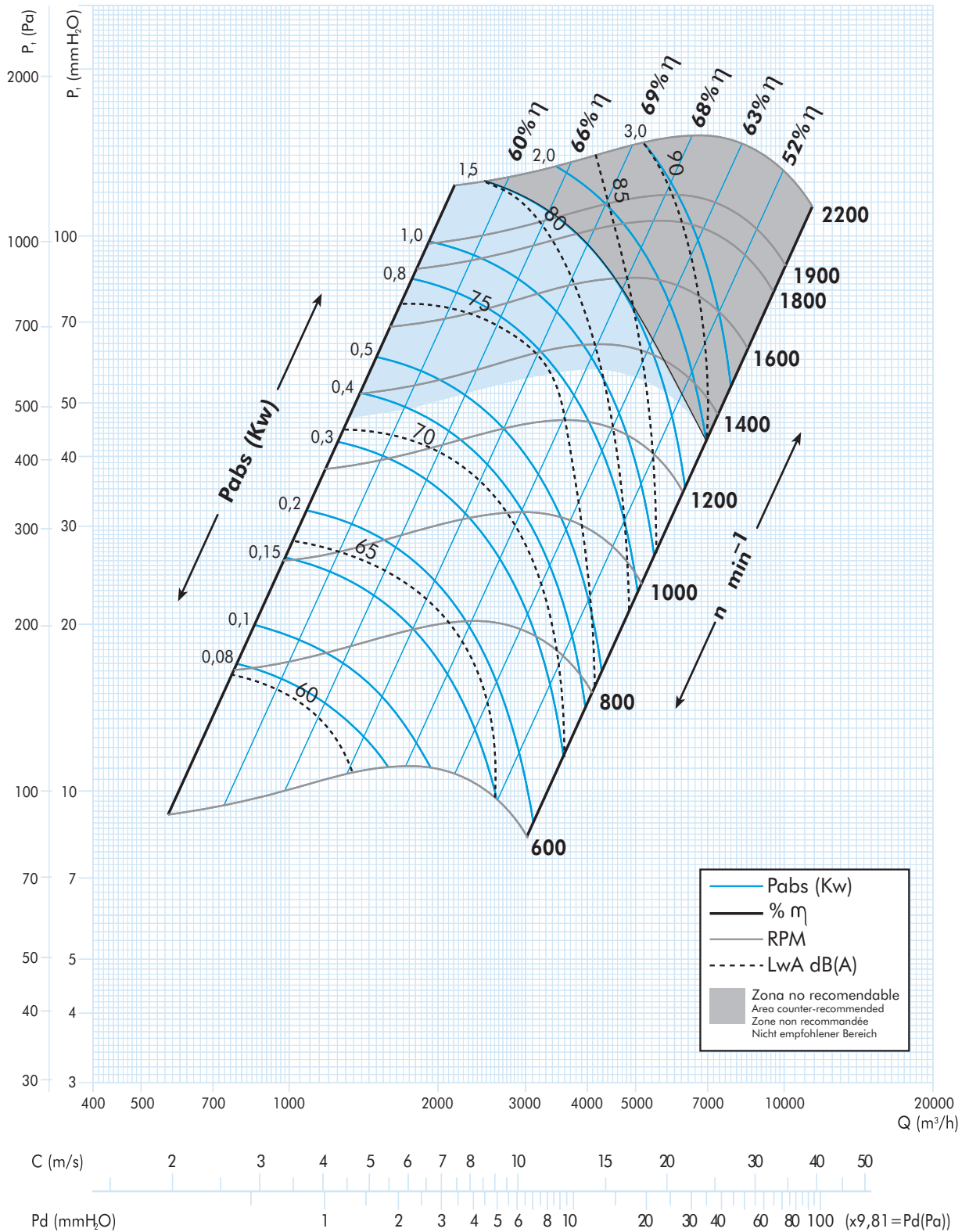

BV, BVC

28/28 (10/10)

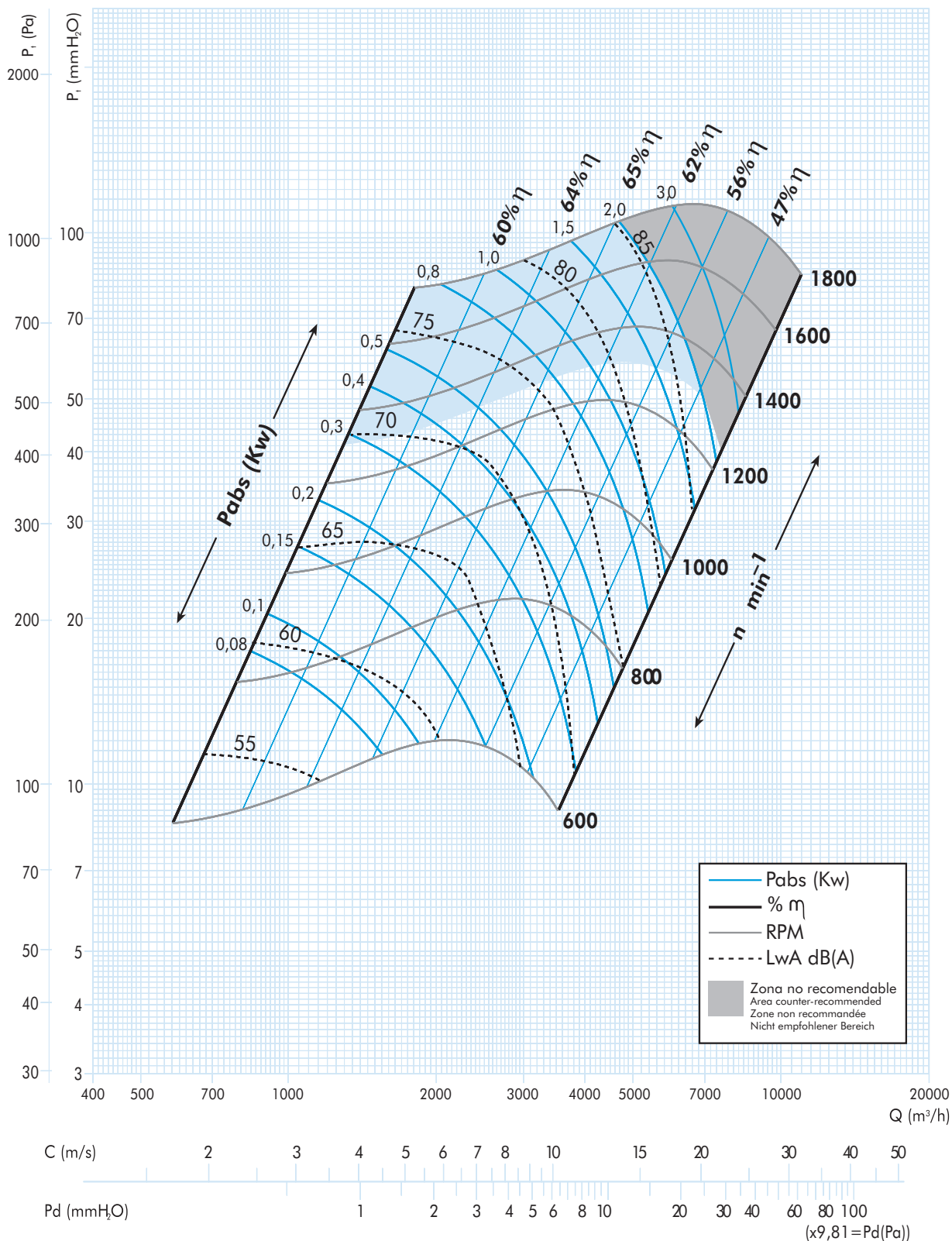

33/25 (12/9)

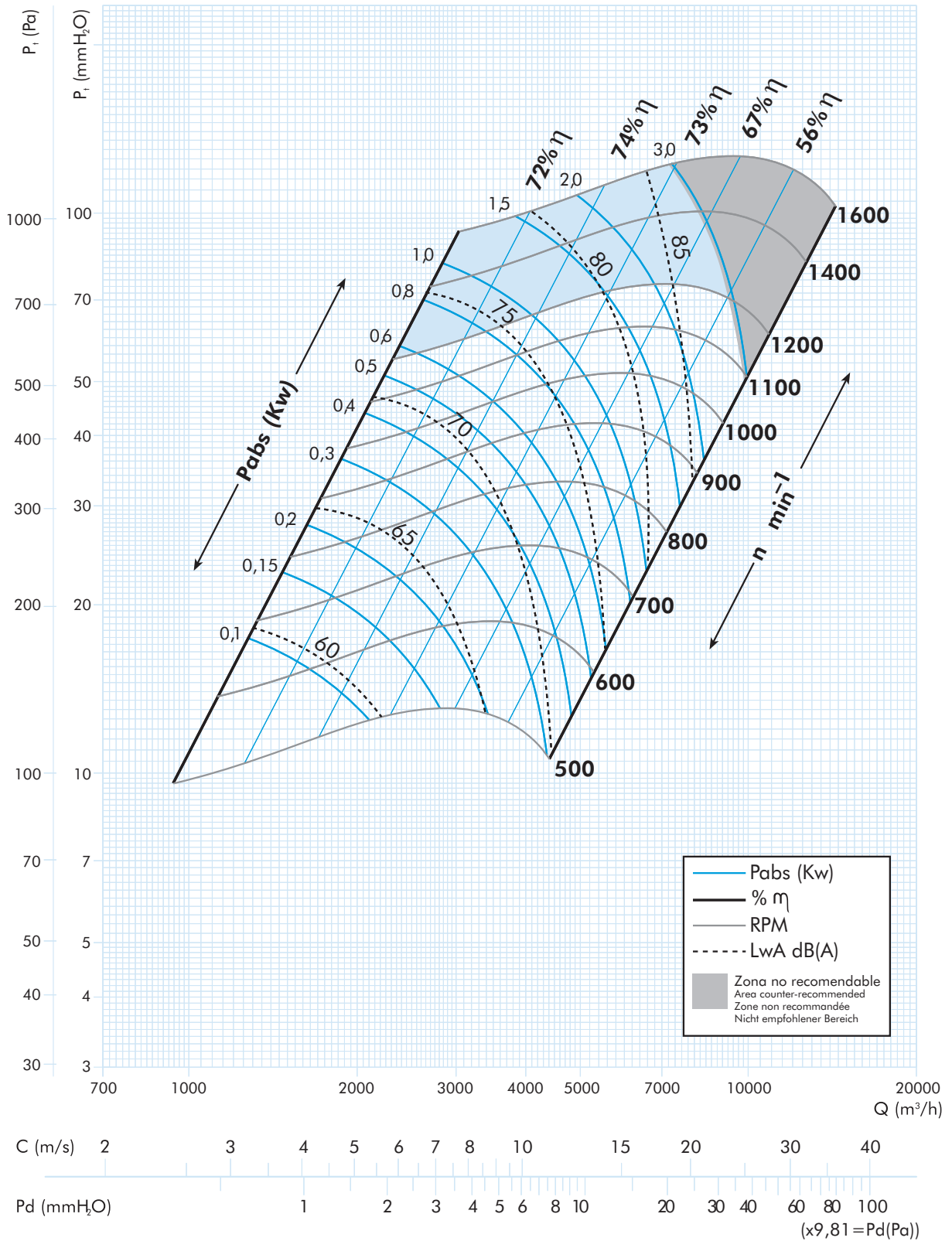

BV, BVC

33/33 (12/12)

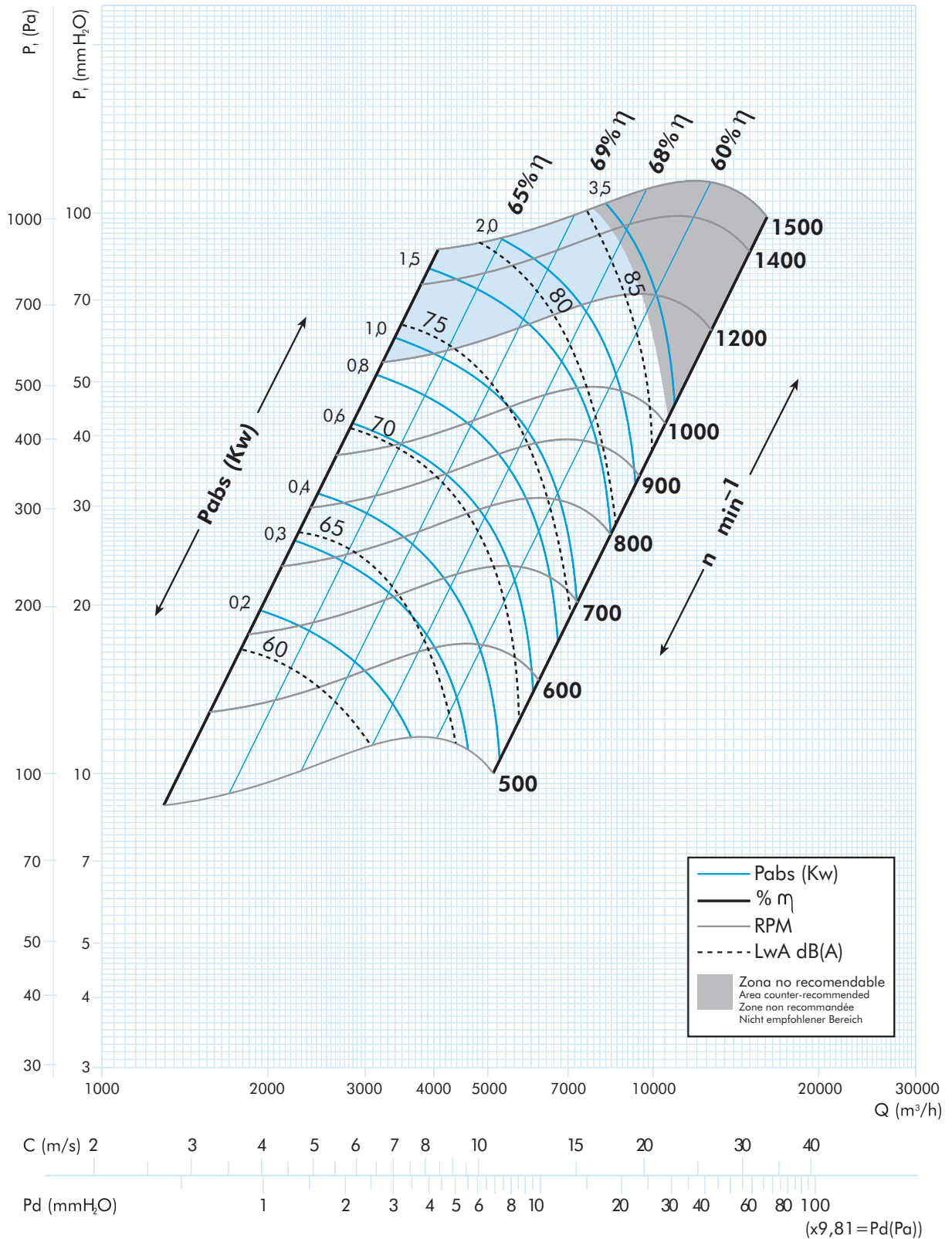

**BV, BVC,
BVCR**

39/39 (15/15)

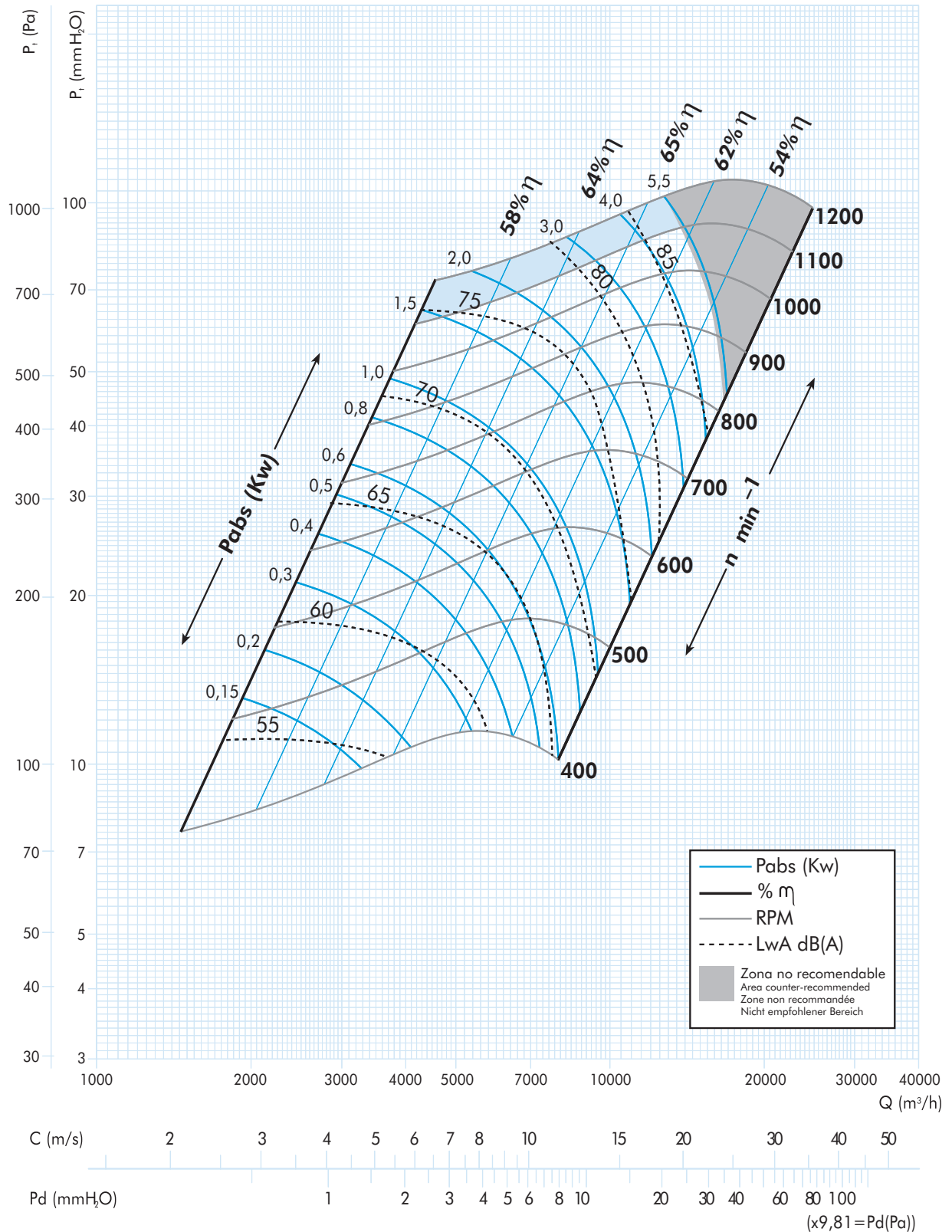

**BV, BVC,
 BVCR**

47/47 (18/18)

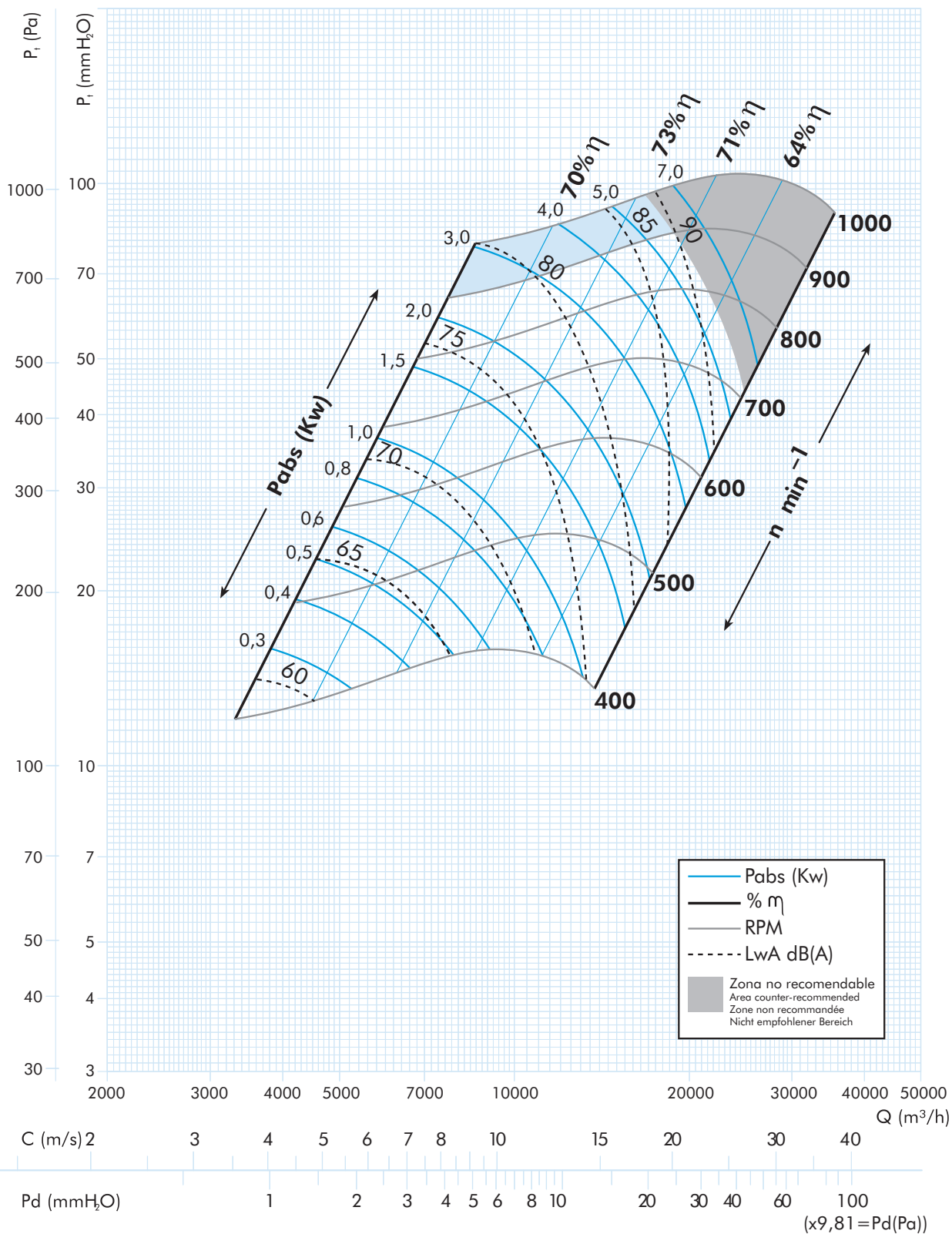

VENTILADORES CENTRÍFUGOS BAJA PRESIÓN
CENTRIFUGAL LOW PRESSURE FANS
VENTILATEURS CENTRIFUGES BASSE PRESSION
NIEDERDRUCK-RADIALVENTILATOREN

BVCR

51/51 (20/20)

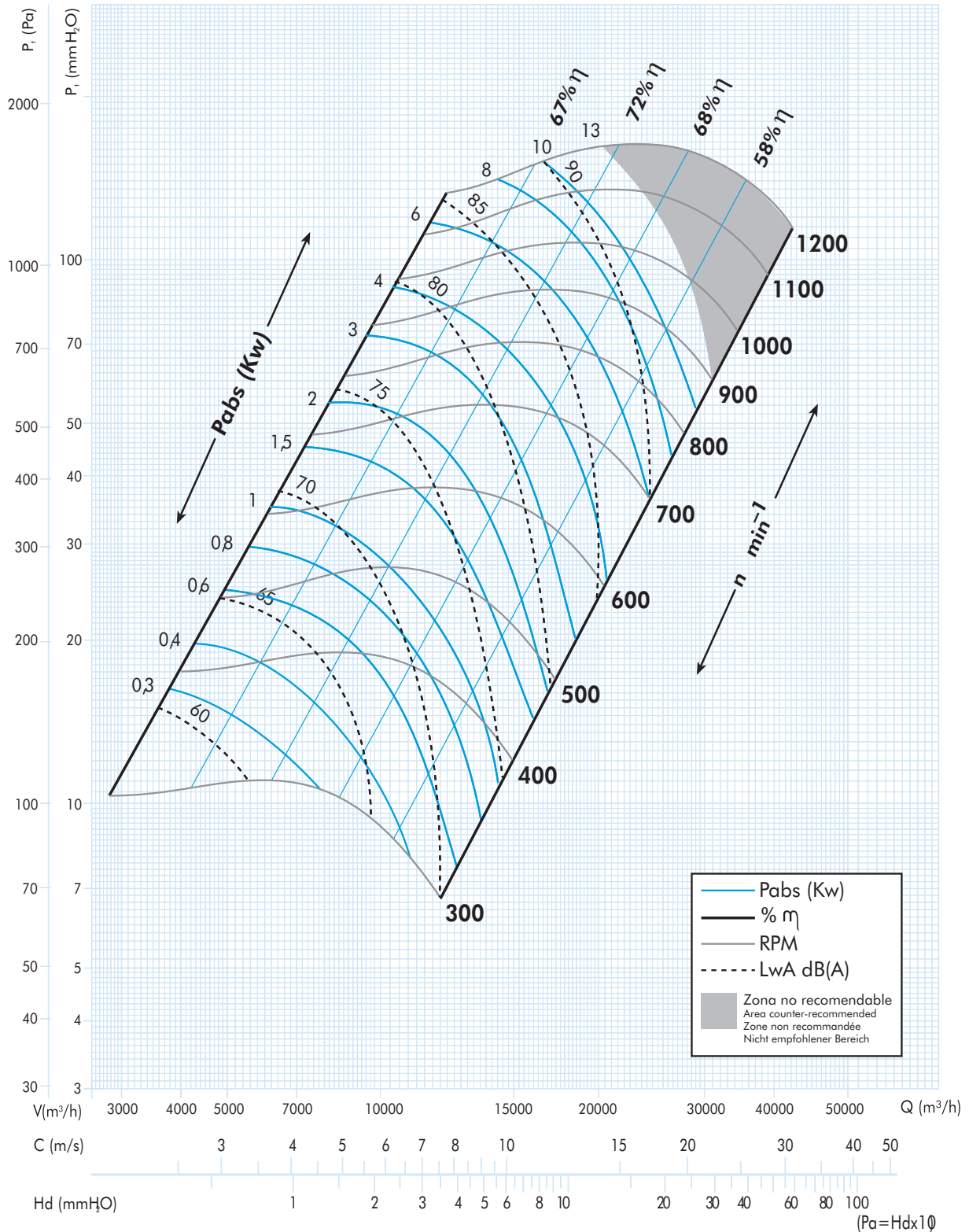

BVCR

56/56 (22/22)

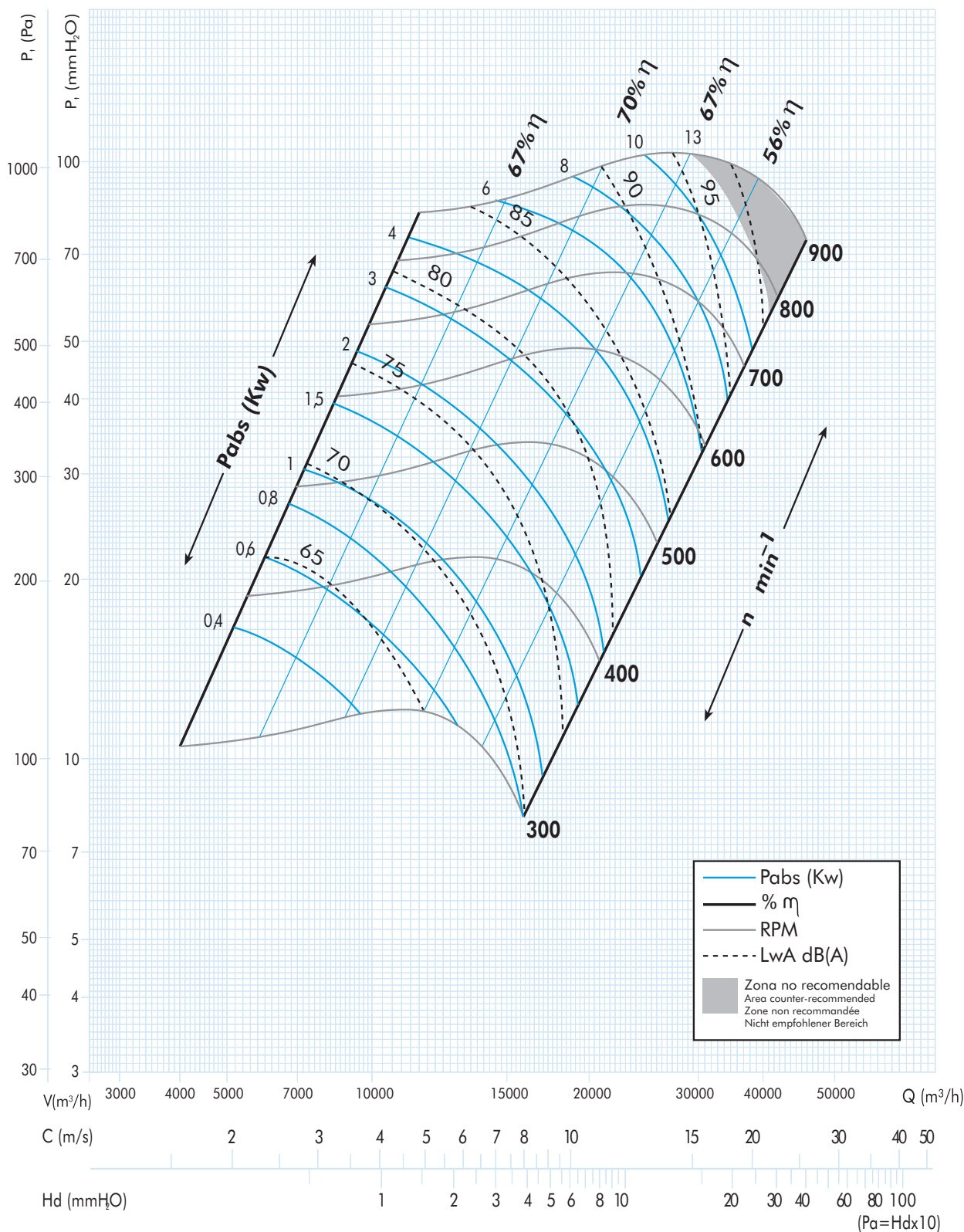

VENTILADORES CENTRÍFUGOS BAJA PRESIÓN
CENTRIFUGAL LOW PRESSURE FANS
VENTILATEURS CENTRIFUGES BASSE PRESSION
NIEDERDRUCK-RADIALVENTILATOREN

BVCR

63/63 (25/25)

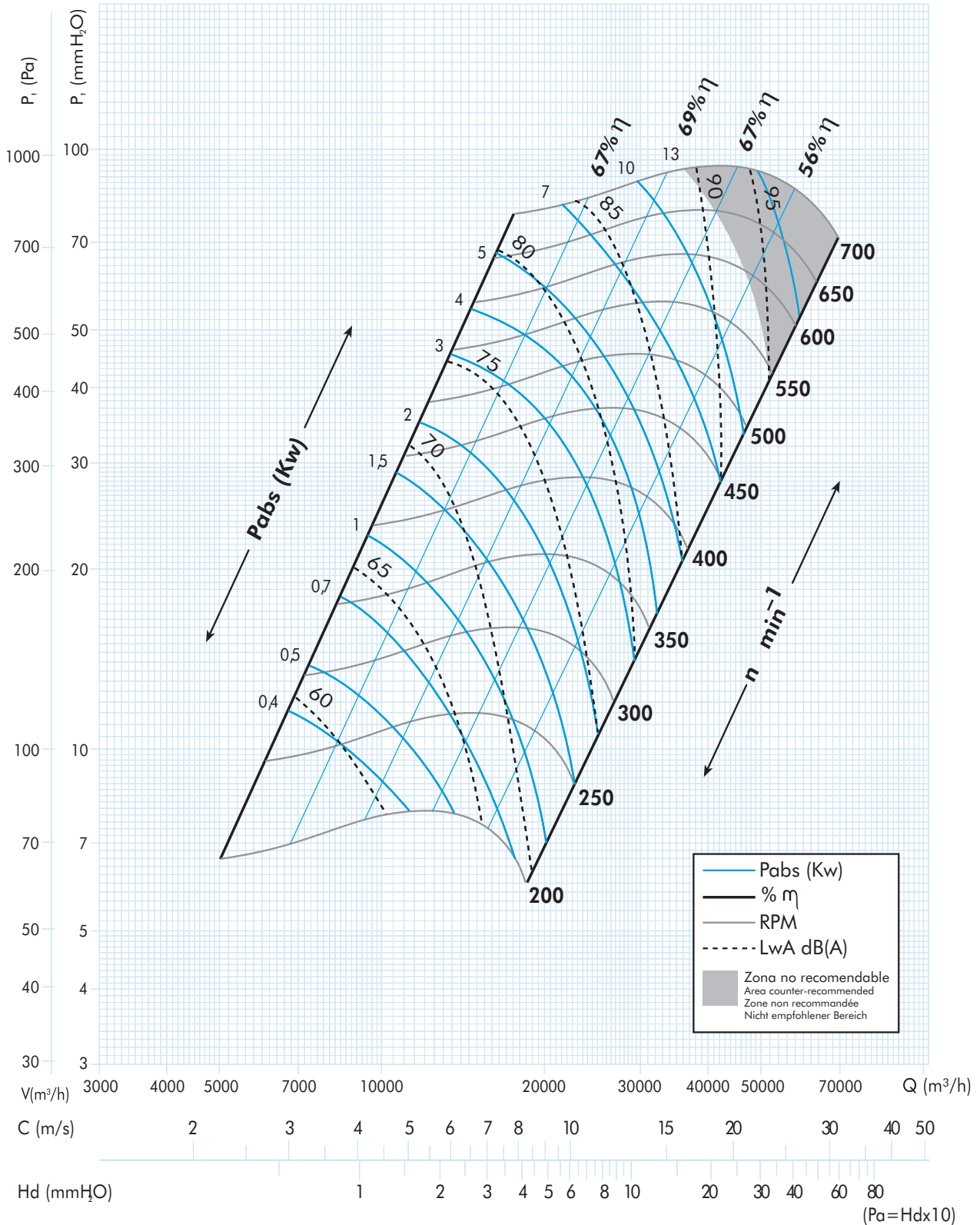

VENTILADORES CENTRÍFUGOS BAJA PRESIÓN
CENTRIFUGAL LOW PRESSURE FANS
VENTILATEURS CENTRIFUGES BASSE PRESSION
NIEDERDRUCK-RADIALVENTILATOREN

BVCR

76/71 (30/28)

